

BUTTERFLY

Active 19 Deluxe Rollaway Table Tennis Table Assembly Instructions



BUTTERFLY

PARTS LIST

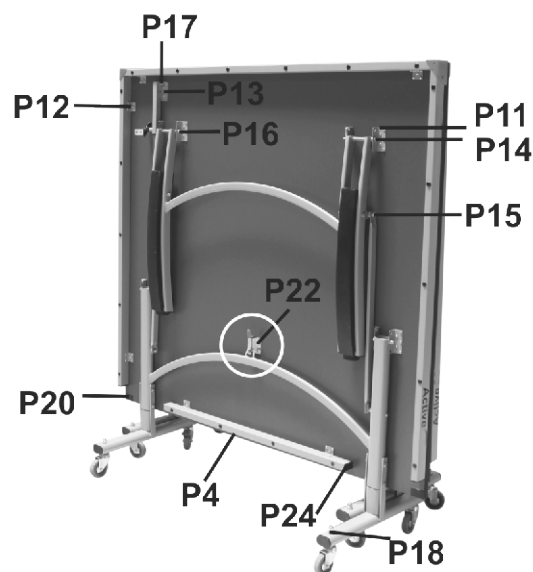
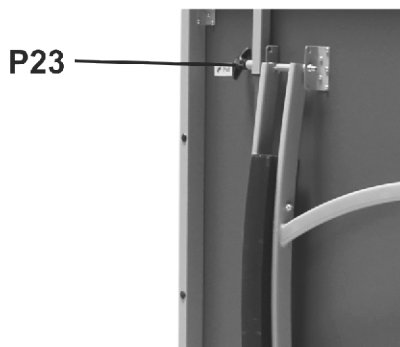
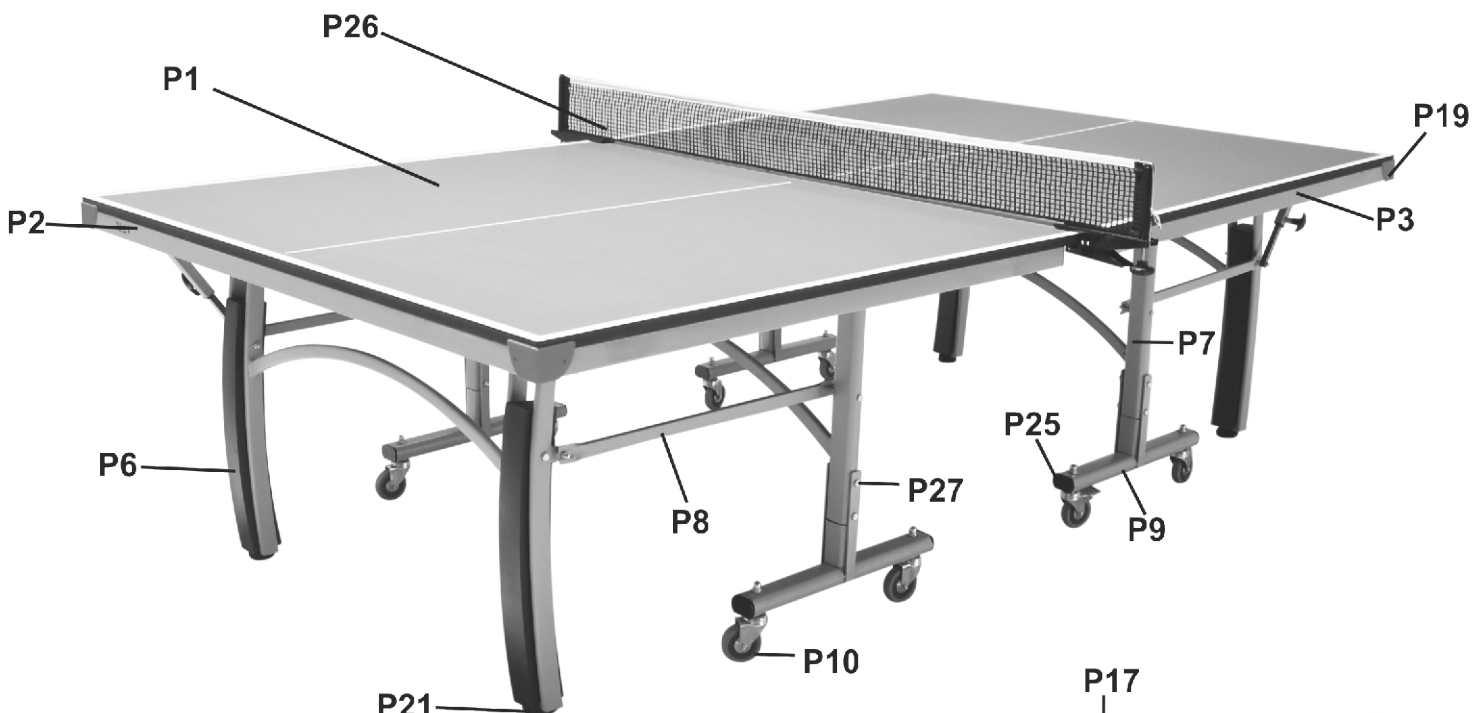

1. TABLE TOP 19 MM PARTICLE BOARD- - 2 NOS.

2. END FRAME PIPE - 2 NOS.

3. SIDE FRAME PIPE - 4 NOS.

4. INNER FRAME PIPE - 2 NOS.

5. SMALL INNER FRAME PIPE - 4 NOS.

6. OUTER LEG - 2 NOS.

7. INNER LEG - 2 NOS.

8. LONG BRACE SUPPORT- 4 NOS.

9. WHEEL ASSEMBLY- 4NOS.

10. SET OF 8 WHEELS - 2 LOCK WHEELS

11. BRACKETS FOR OUTER/INNER LEG - 16 NOS.

12. BRACKETS FOR FRAME PIPE - 20 NOS.

13. BRACKETS FOR SIDE LOCK - - 4NOS.

14. BOLTS FOR OUTER/INNER LEG - 8 NOS.

15. BOLTS FOR LONG BRACE SUPPORT FIXED TO OUTER/INNER LEG - 6 NOS.

16. BOLTS FOR SIDE LOCK ATTACHED TO OUTER LEG - WITH NUT WASHER AND BHOGLI - 2NOS.

17. BOLTS FOR SIDE LOCK ATTACHED TO BRACKET - 2 NOS.

18. DOME NUT - 8 NOS.

19. OUTER CORNER - 4 NOS.

20. SET OF POST CORNER - 2 NOS.

21. LEVELLERS - 4 NOS.

22. CENTRE LOCK - 2 NOS.

23. SIDE LOCK - 2 NOS.

24. PLASTIC CAPS FOR INNER FRAME PIPE - 8 NOS.

25 WHEEL ASSEMBLY CAP - 8 NOS.

26. NET POST SET - 1 NOS.

27. BOLTS TO ATTACHED WHEEL ASSEMBLY (P9) WITH INNER LEG (P7) - 8 NOS.

28. SPARE NET - 1 NOS.

29. SPANNER - 2 NOS.

30. NUT AND BOLT - 4 NOS.

31. WOOD PART FOR LEGS - 4 NOS.

BUTTERFLY



P-27 QTY. - 8

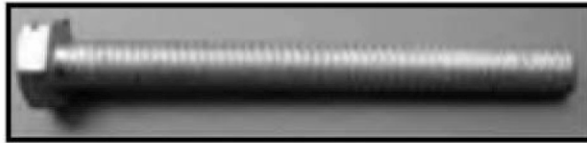

P-27 QTY. - 8

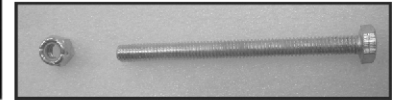

P-30 QTY. - 4



P-29- QTY. - 2

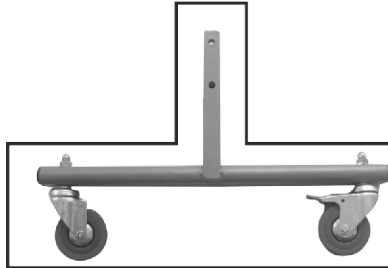

P-9 - QTY. - 4

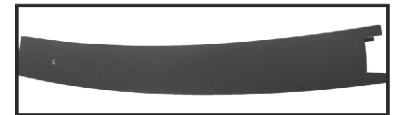

P-31 - QTY. - 4

ADULT ASSEMBLY REQUIRED

PLEASE READ THE SAFETY INSTRUCTIONS AT THE BOTTOM OF PAGE- 4

STEP - 1

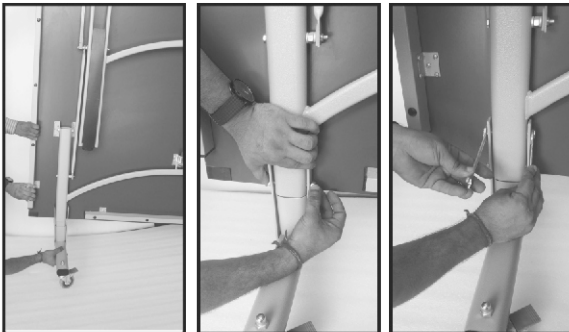

FIX THE WHEEL ASSEMBLY (P9) TO BOTH INNER (P7) LEGS OF EACH HALF OF THE TABLE USING NUT & BOLTS (P27) & TIGHTEN IT WITH THE HELP OF 2 SPANNERS.

STEP - 2

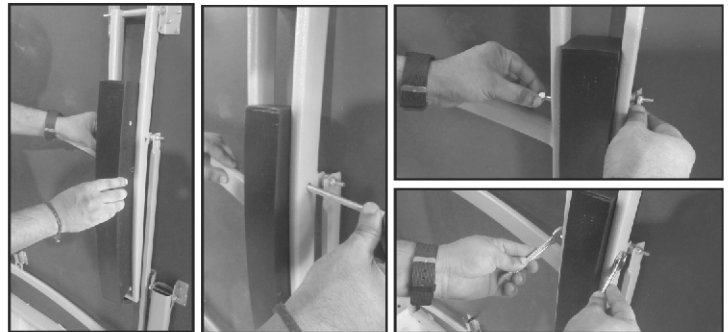

ATTACH P31 BETWEEN OUTER LEGS WITH THE HELP OF NUT AND BOLT P30 AND TIGHTEN IT WITH THE HELP OF TWO SPANNER.

STEP- 3

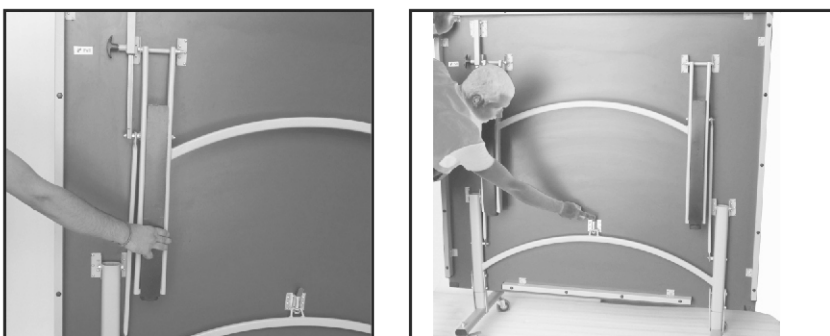

SLIGHTLY PULL OUT THE OUTER LEGS (P6) & PUSH OPEN THE TABLE SLIGHTLY BY OPENING CENTRE LOCK (P22).



BUTTERFLY

STEP- 4

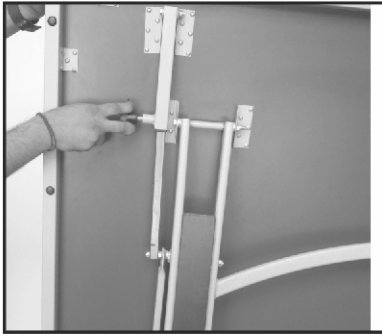

NOW SLIGHTLY PULL OUT THE SIDE LOCK (P23) & SLOWLY BRING DOWN THE TABLE

STEP- 5

REPEAT THE SAME FOR THE 2ND HALF OF THE TABLE AS IN STEP- 1, 2, 3 & 4

STEP- 6

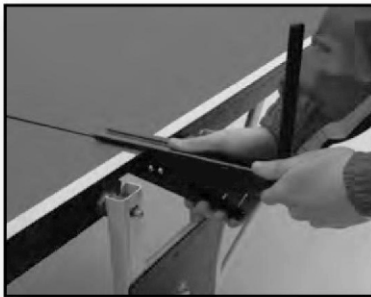

Attach posts to the left and right side of the table.

STEP- 7



Place net onto posts, feed string through grooves.

Adjust tension of the net with the chains.

STEP- 8

ADJUST THE HEIGHT REQUIRED WITH THE HELP OF LEVELLERS (P21) ATTACHED ON ALL 4 OUTER LEGS (P6).

YOUR TABLE IS NOW READY FOR PLAY

STEP- 1

STORING THE TABLE

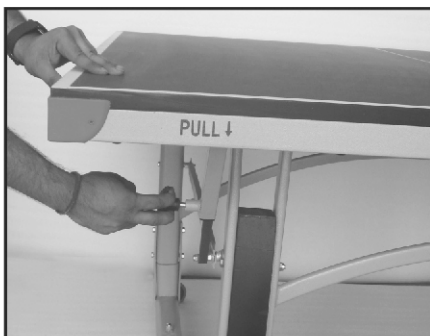

PULL OUT THE SIDE LOCK (P23) TO LIFT THE TABLE ON THE WHEELS. MAKE SURE THAT LOCK (P22) IS LOCKED PROPERLY FOR STORAGE

STEP- 2 REPEAT THE SAME FOR THE 2ND HALF.

Safety Instructions: Children below 14 years should not assemble the table. When lowering each half of the table top, make sure that the outer legs P6 are pulled gently outwards from the underside of the table, so far as they can go. Failure to do this may result in injury or damage to the table. This table is suitable for indoor use. It can be used outdoors provided that it is not exposed to direct sunlight rain or frost. It should always be stored indoors. Make sure that the wheel brakes are off when moving the table and are on when the table is stored or in the play position.